

PLANTA DE FUNDACIONES Y COLUMNAS
ESCALA 1:50

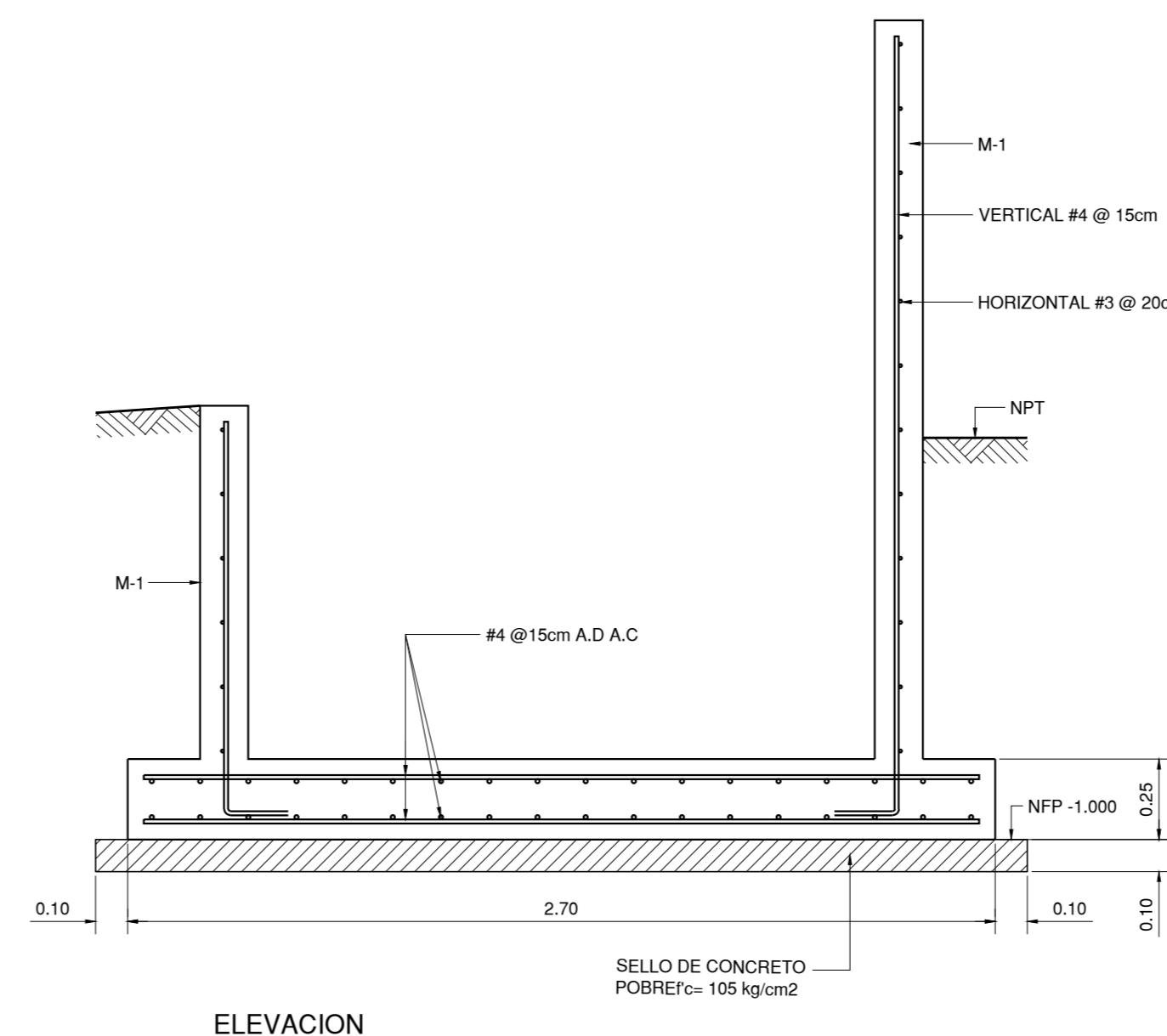

PLACA TIPO P-1
ESCALA 1:20

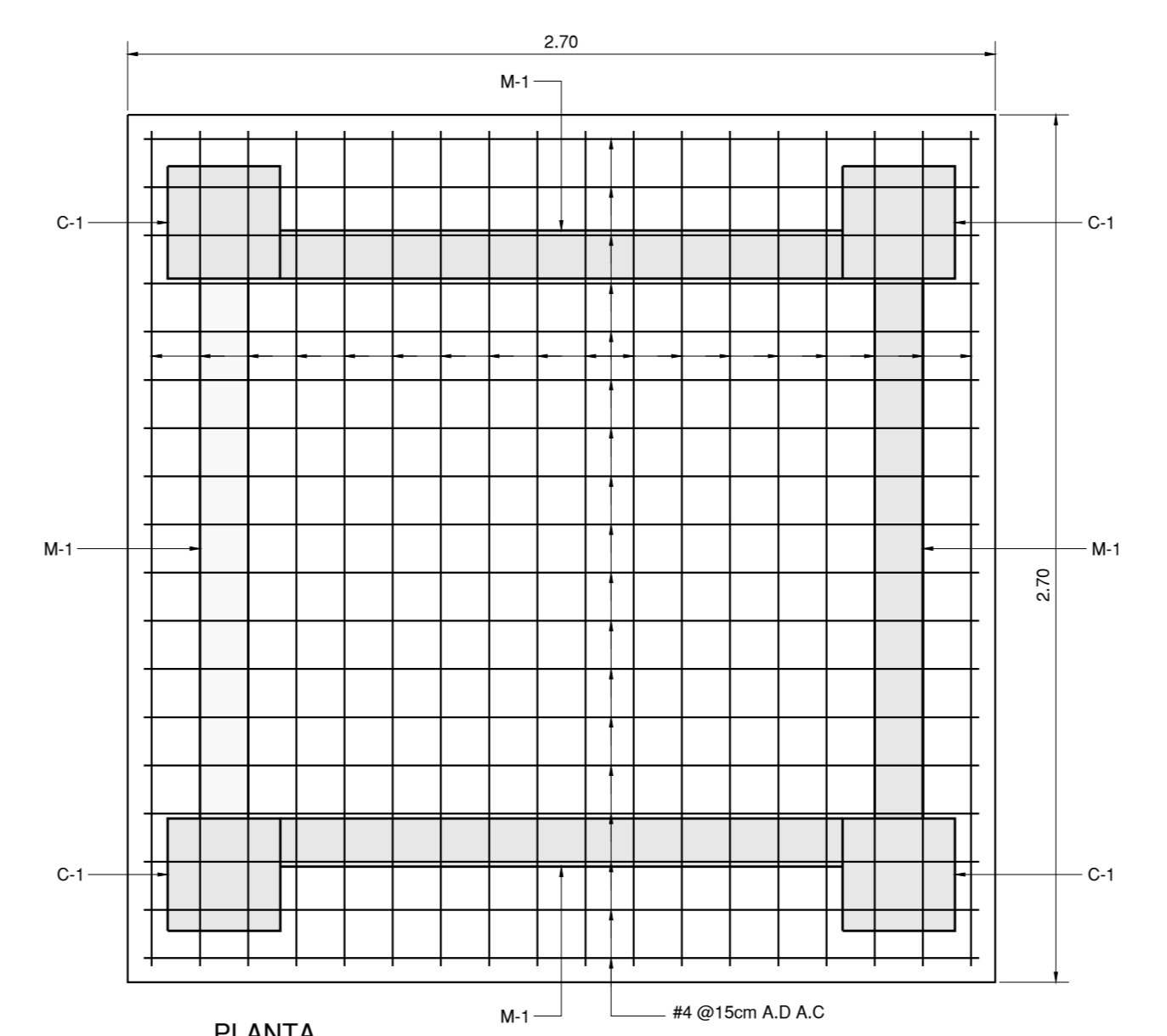
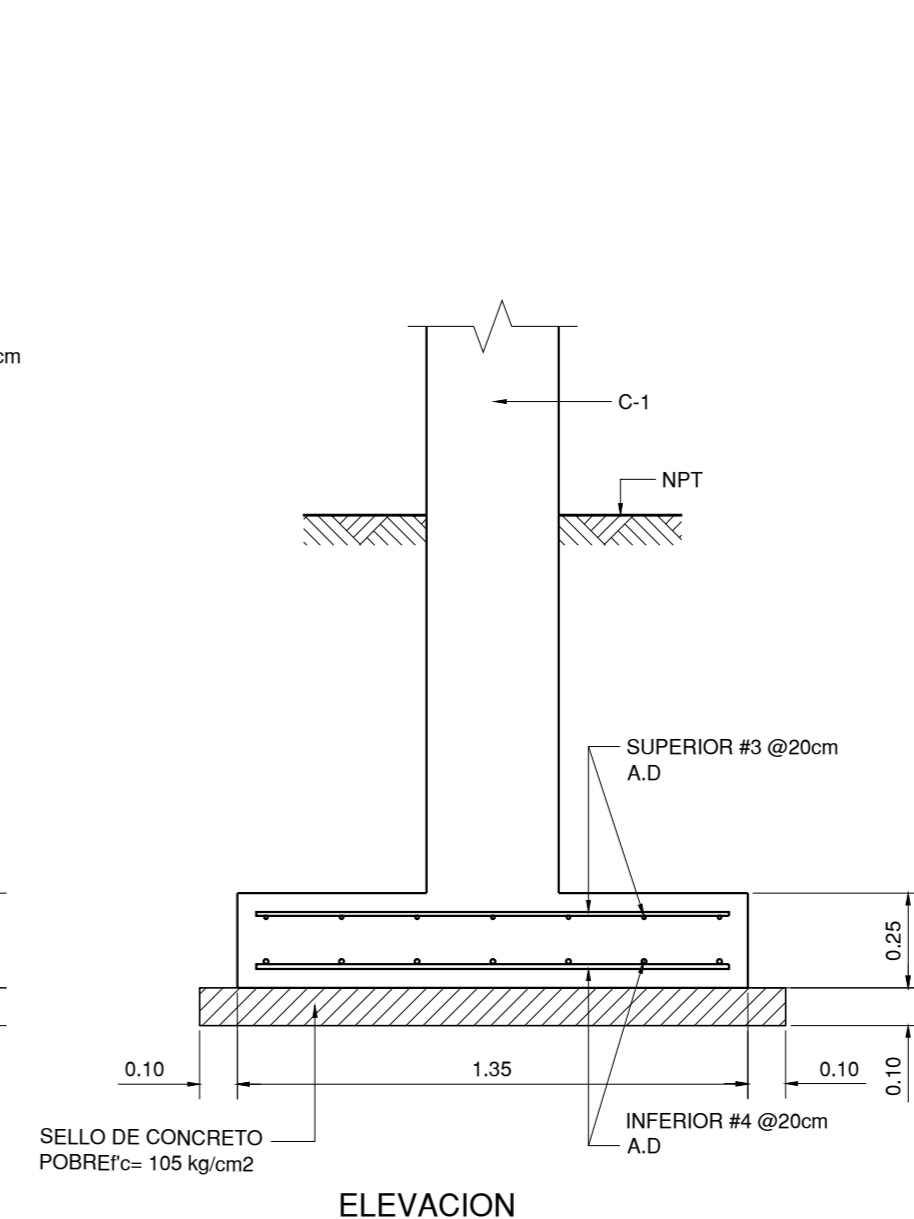
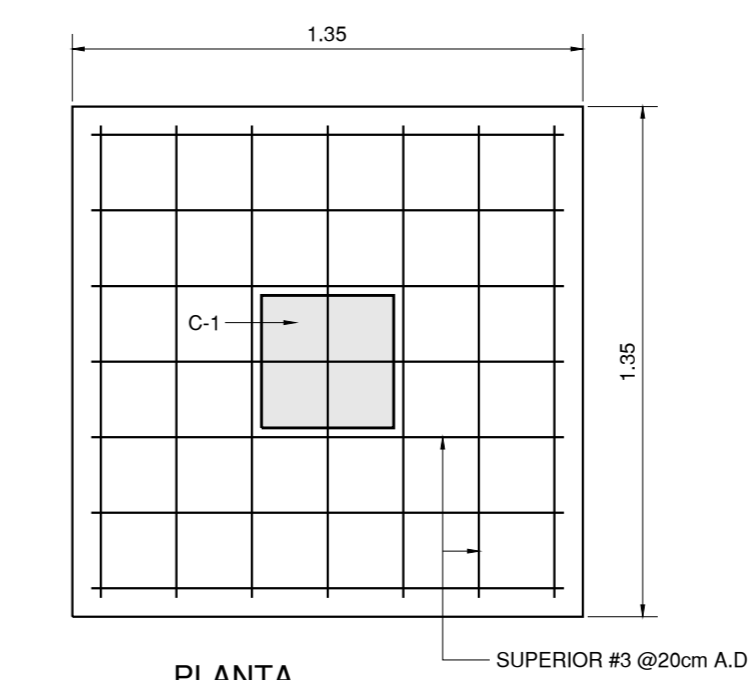

PLACA TIPO P-2
ESCALA 1:20

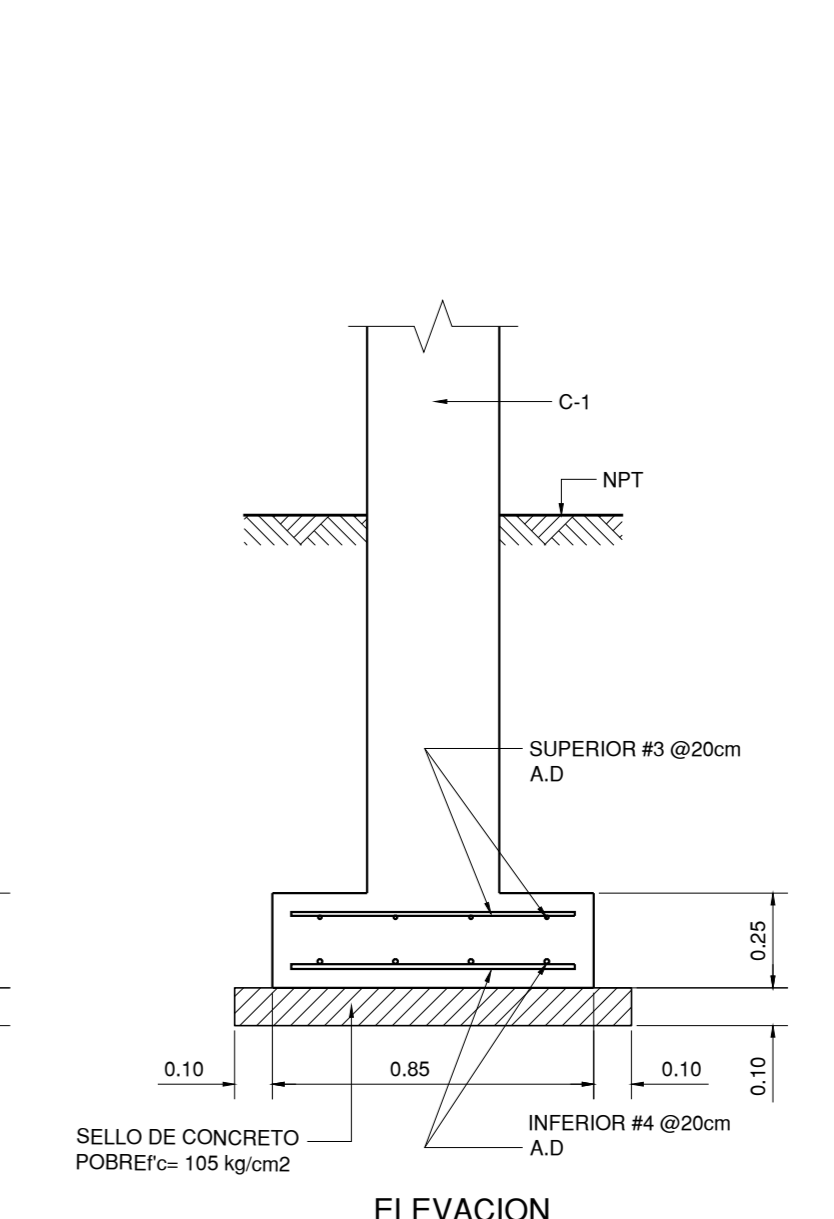
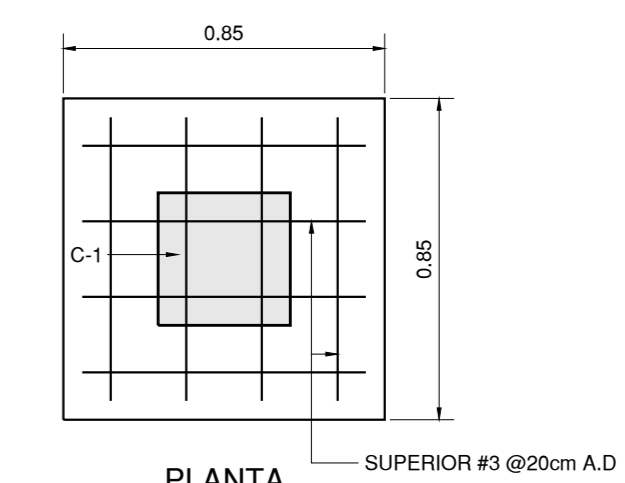

PLACA TIPO P-3
ESCALA 1:20

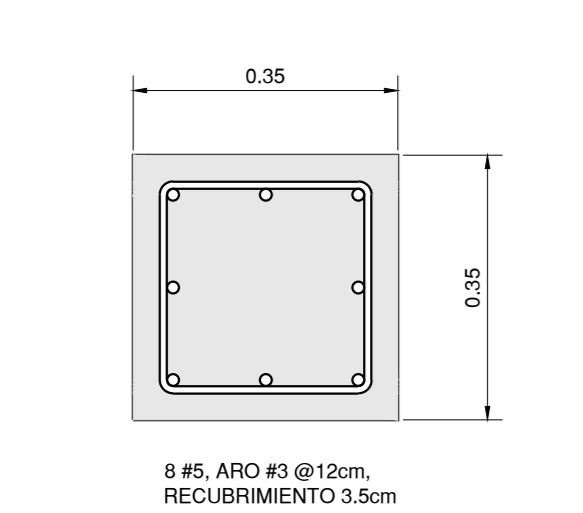

COLUMNA TIPO C-1
ESCALA 1:10

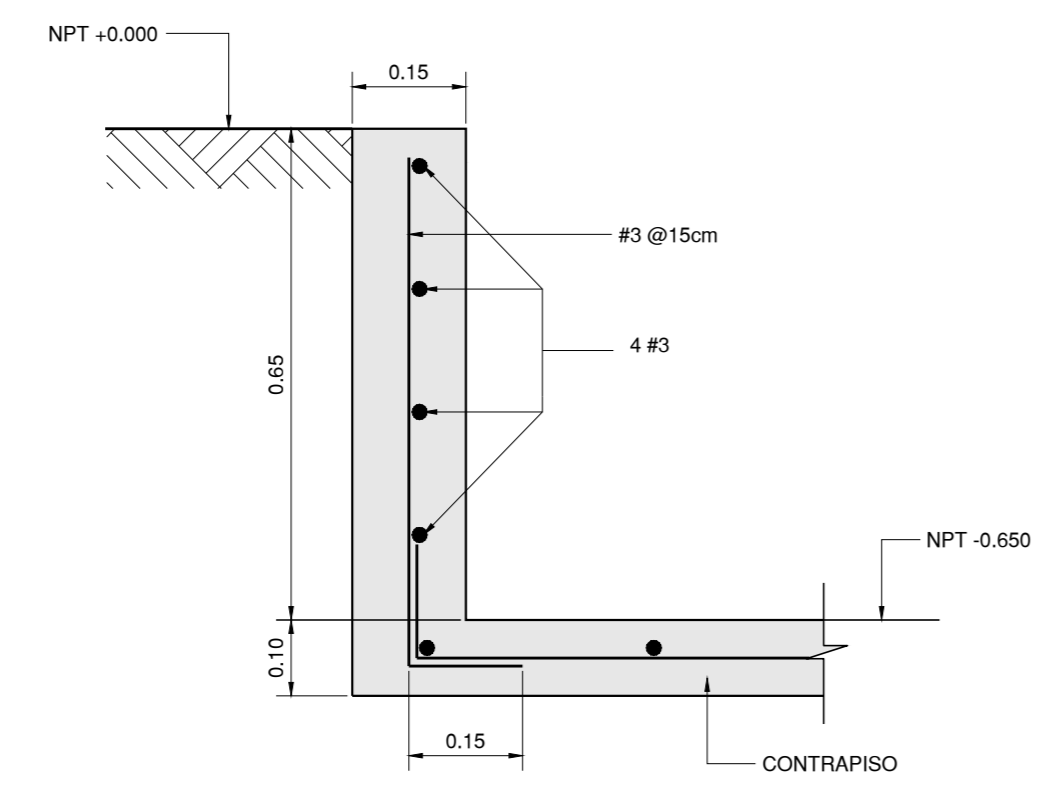

DETALLE DE MURO DE CONTENCIÓN
ESCALA 1:10

CONTENIDO:	
PLANTA DE FUNDACIONES Y COLUMNAS	
DETALLE DE PLACAS	
DETALLE DE COLUMNAS	
INFORMACION DEL REGISTRO PUBLICO:	
PROPIETARIO:	UNIVERSIDAD DE COSTA RICA
# DE CATASTRO:	G-368415-1979
SITAS:	FR-5-30534-000
FECHA:	# DE LÁMINA:
OCTUBRE-2016	S02/11